

# N-Channel MOS-Fieldeffect Triode, Depletion Mode

Electrostatic sensitive device.

Observe precautions for handling.



## Applications

High frequency stages up to 300 MHz.

## Features

- Integrated gate protection diodes
- Low feedback capacitance
- Low noise figure

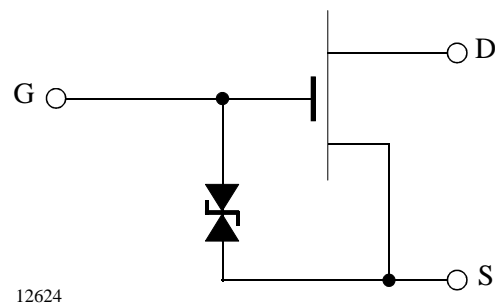
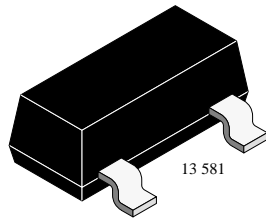
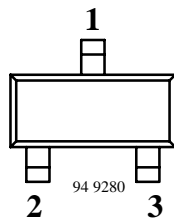

S525T Marking: LB

Plastic case (SOT 23)

1=Source, 2=Gate, 3=Drain

## Absolute Maximum Ratings

 $T_{amb} = 25^{\circ}\text{C}$ , unless otherwise specified

Parameter	Test Conditions	Type	Symbol	Value	Unit
Drain - source voltage			$V_{DS}$	20	V
Drain current			$I_D$	30	mA
Gate-source peak current			$\pm I_{GSM}$	10	mA
Total power dissipation	$T_{amb} \leq 60^{\circ}\text{C}$		$P_{tot}$	200	mW
Channel temperature			$T_{Ch}$	150	$^{\circ}\text{C}$
Storage temperature range			$T_{stg}$	-55 to +150	$^{\circ}\text{C}$

## Maximum Thermal Resistance

 $T_{amb} = 25^{\circ}\text{C}$ , unless otherwise specified

Parameter	Test Conditions	Symbol	Value	Unit
Channel ambient	on glass fibre printed board (25 x 20 x 1.5) mm <sup>3</sup> plated with 35 $\mu\text{m}$ Cu	$R_{thChA}$	450	K/W

## Electrical DC Characteristics

$T_{amb} = 25^{\circ}\text{C}$ , unless otherwise specified

Parameter	Test Conditions	Symbol	Min	Typ	Max	Unit
Drain - source breakdown voltage	$I_D = 10 \mu\text{A}$ , $-V_{GS} = 4 \text{ V}$	$V_{(BR)DS}$	20			V
Gate - source breakdown voltage	$\pm I_{GS} = 10 \text{ mA}$ , $V_{DS} = 0$	$\pm V_{(BR)GSS}$	7.5		12	V
Gate - source leakage current	$\pm V_{GS} = 6 \text{ V}$ , $V_{DS} = 0$	$\pm I_{GSS}$			50	nA
Drain current	$V_{DS} = 10 \text{ V}$ , $V_{GS} = 0$	$I_{DSS}$	5		14	mA
Gate - source cut-off voltage	$V_{DS} = 10 \text{ V}$ , $I_D = 20 \mu\text{A}$	$-V_{GS(OFF)}$			2.5	V

## Electrical AC Characteristics

$V_{DS} = 10 \text{ V}$ ,  $I_D = 10 \text{ mA}$ ,  $f = 1 \text{ MHz}$ ,  $T_{amb} = 25^{\circ}\text{C}$ , unless otherwise specified

Parameter	Test Conditions	Symbol	Min	Typ	Max	Unit
Forward transadmittance		$ y_{21s} $	14	16		mS
Gate input capacitance		$C_{issg1}$		2.7		pF
Feedback capacitance		$C_{rss}$		25		fF
Output capacitance		$C_{oss}$		1.0		pF
Noise figure	$G_S = 2 \text{ mS}$ , $G_L = 0.5 \text{ mS}$ , $f = 200 \text{ MHz}$	F		1.0		dB
Power gain	$G_S = 2 \text{ mS}$ , $G_L = 0.5 \text{ mS}$ , $f = 200 \text{ MHz}$	$G_{ps}$		25		dB

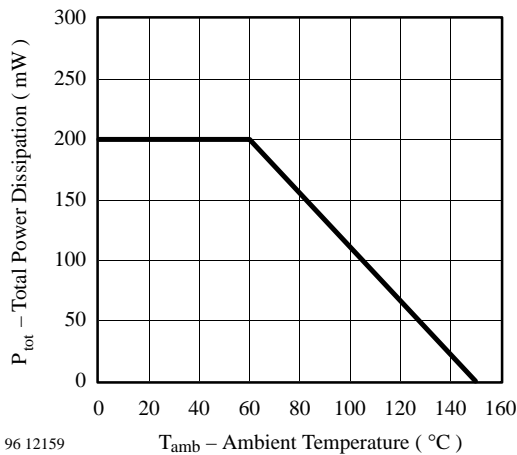
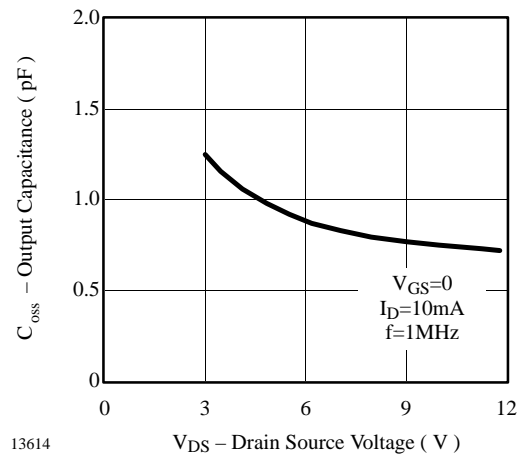
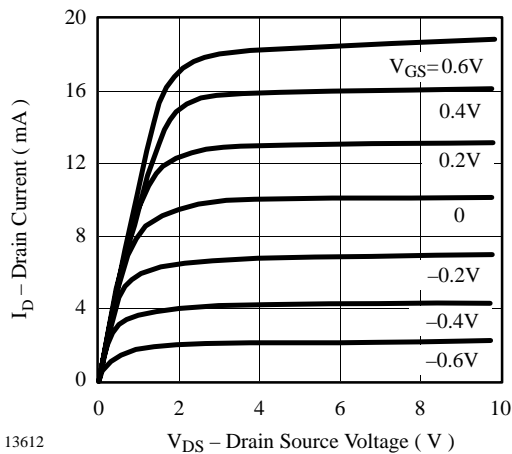
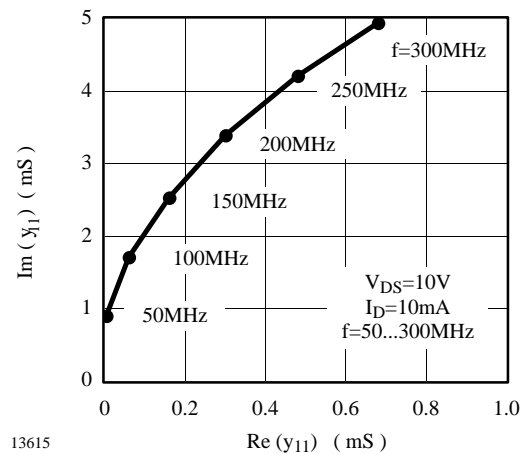
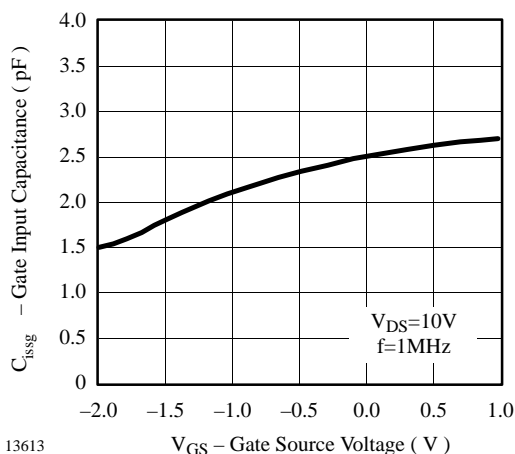
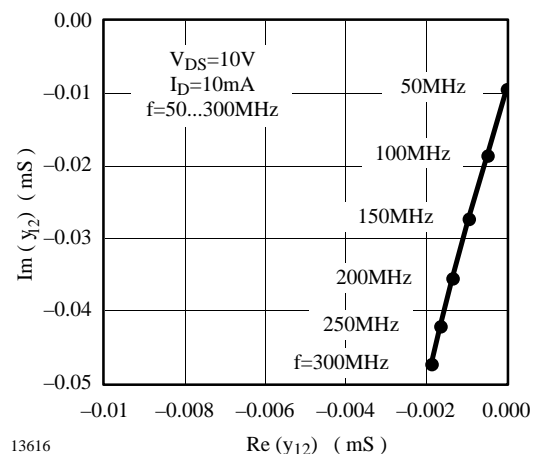
**Typical Characteristics** ( $T_{amb} = 25^{\circ}\text{C}$  unless otherwise specified)

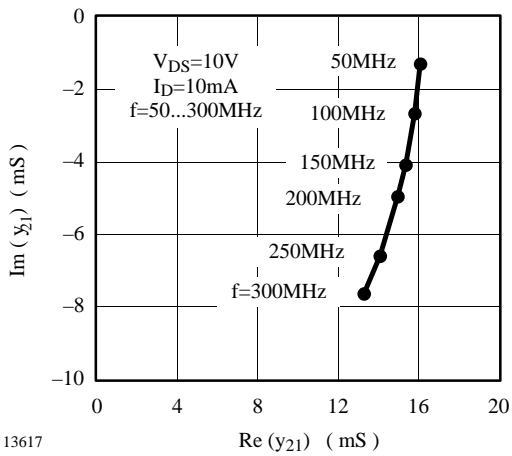
**Figure 1. Total Power Dissipation vs. Ambient Temperature**

**Figure 4. Output Capacitance vs. Drain Source Voltage**

**Figure 2. Drain Current vs. Drain Source Voltage**

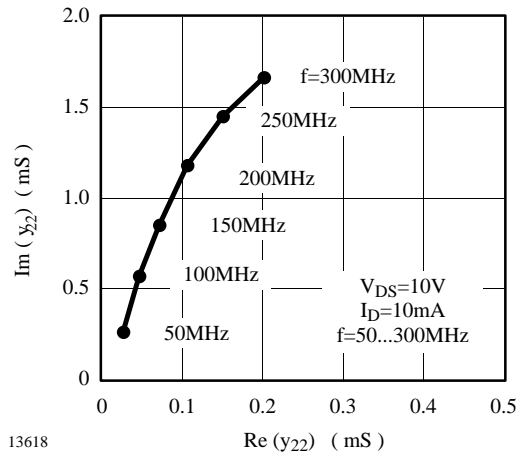
**Figure 5. Short Circuit Input Admittance**

**Figure 3. Gate Input Capacitance vs. Gate Source Voltage**

**Figure 6. Short Circuit Reverse Transfer Admittance**



13617

Figure 7. Short Circuit Forward Transfer Admittance



13618

Figure 8. Short Circuit Output Admittance

$V_{DS} = 10 \text{ V}$ ,  $I_D = 10 \text{ mA}$ ,  $Z_0 = 50 \Omega$

$S_{11}$

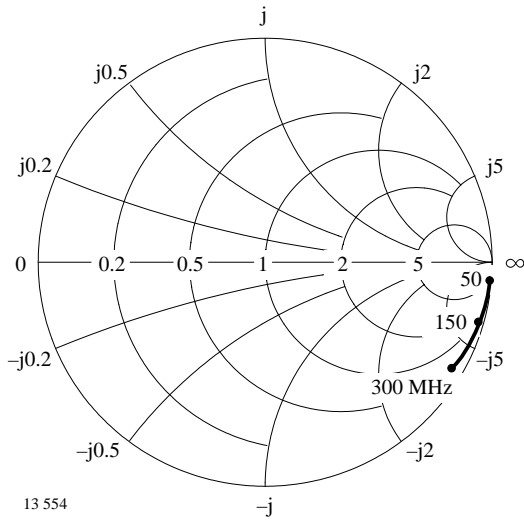

Figure 9.

$S_{12}$

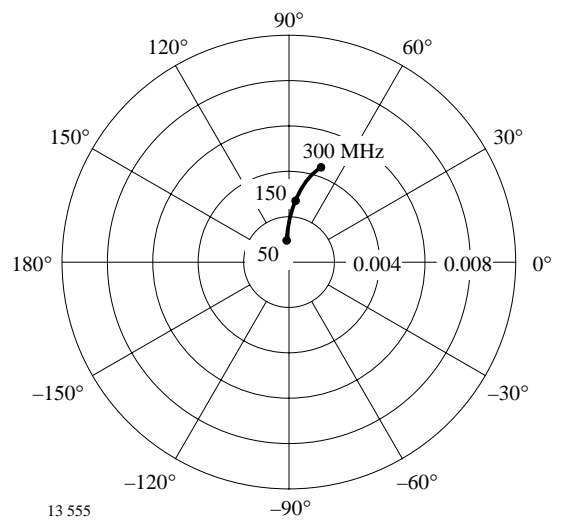

Figure 11.

$S_{21}$

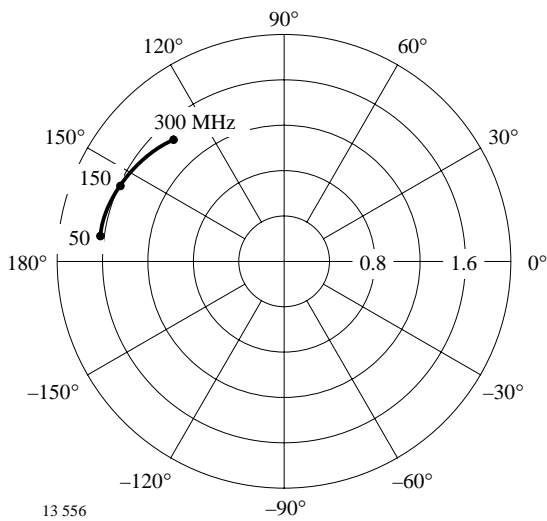

Figure 10.

$S_{22}$

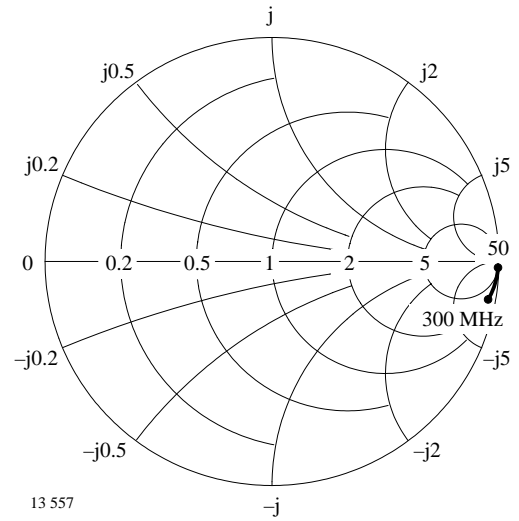

Figure 12.





## Ozone Depleting Substances Policy Statement

It is the policy of **Vishay Semiconductor GmbH** to

1. Meet all present and future national and international statutory requirements.
2. Regularly and continuously improve the performance of our products, processes, distribution and operating systems with respect to their impact on the health and safety of our employees and the public, as well as their impact on the environment.

It is particular concern to control or eliminate releases of those substances into the atmosphere which are known as ozone depleting substances (ODSs).

The Montreal Protocol (1987) and its London Amendments (1990) intend to severely restrict the use of ODSs and forbid their use within the next ten years. Various national and international initiatives are pressing for an earlier ban on these substances.

**Vishay Semiconductor GmbH** has been able to use its policy of continuous improvements to eliminate the use of ODSs listed in the following documents.

1. Annex A, B and list of transitional substances of the Montreal Protocol and the London Amendments respectively
2. Class I and II ozone depleting substances in the Clean Air Act Amendments of 1990 by the Environmental Protection Agency (EPA) in the USA
3. Council Decision 88/540/EEC and 91/690/EEC Annex A, B and C (transitional substances) respectively.

**Vishay Semiconductor GmbH** can certify that our semiconductors are not manufactured with ozone depleting substances and do not contain such substances.

**We reserve the right to make changes to improve technical design and may do so without further notice.**

Parameters can vary in different applications. All operating parameters must be validated for each customer application by the customer. Should the buyer use Vishay-Telefunken products for any unintended or unauthorized application, the buyer shall indemnify Vishay-Telefunken against all claims, costs, damages, and expenses, arising out of, directly or indirectly, any claim of personal damage, injury or death associated with such unintended or unauthorized use.

Vishay Semiconductor GmbH, P.O.B. 3535, D-74025 Heilbronn, Germany  
Telephone: 49 (0)7131 67 2831, Fax number: 49 (0)7131 67 2423